

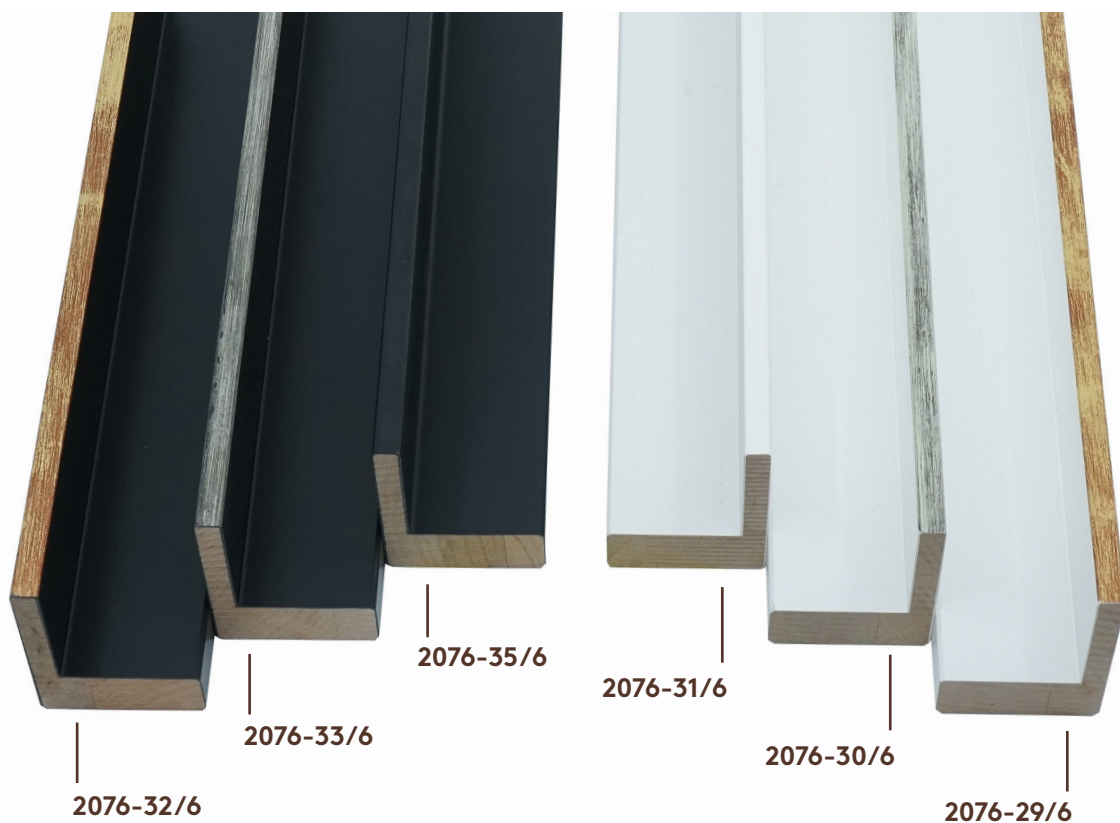

nouveautés baguettes finies
2023



Kian

Tilleul // Europe, Amérique du Nord, Russie

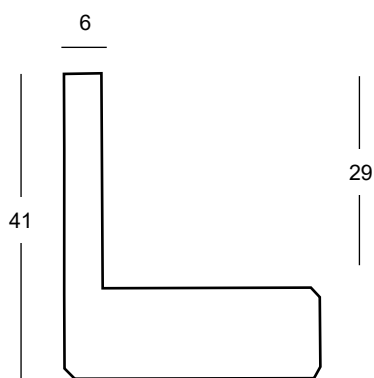

N° d'article	Désignation	N° tarif	Prix/ml
10284	2076-29/6 blanc avec bord or	4280	27.90
10285	2076-30/6 blanc avec bord argent	4280	27.90
10286	2076-31/6 blanc mat	4240	24.00
10287	2076-32/6 noir avec bord or	4280	27.90
10288	2076-33/6 noir avec bord argent	4280	27.90
10289	2076-35/6 noir mat	4240	24.00

1:1

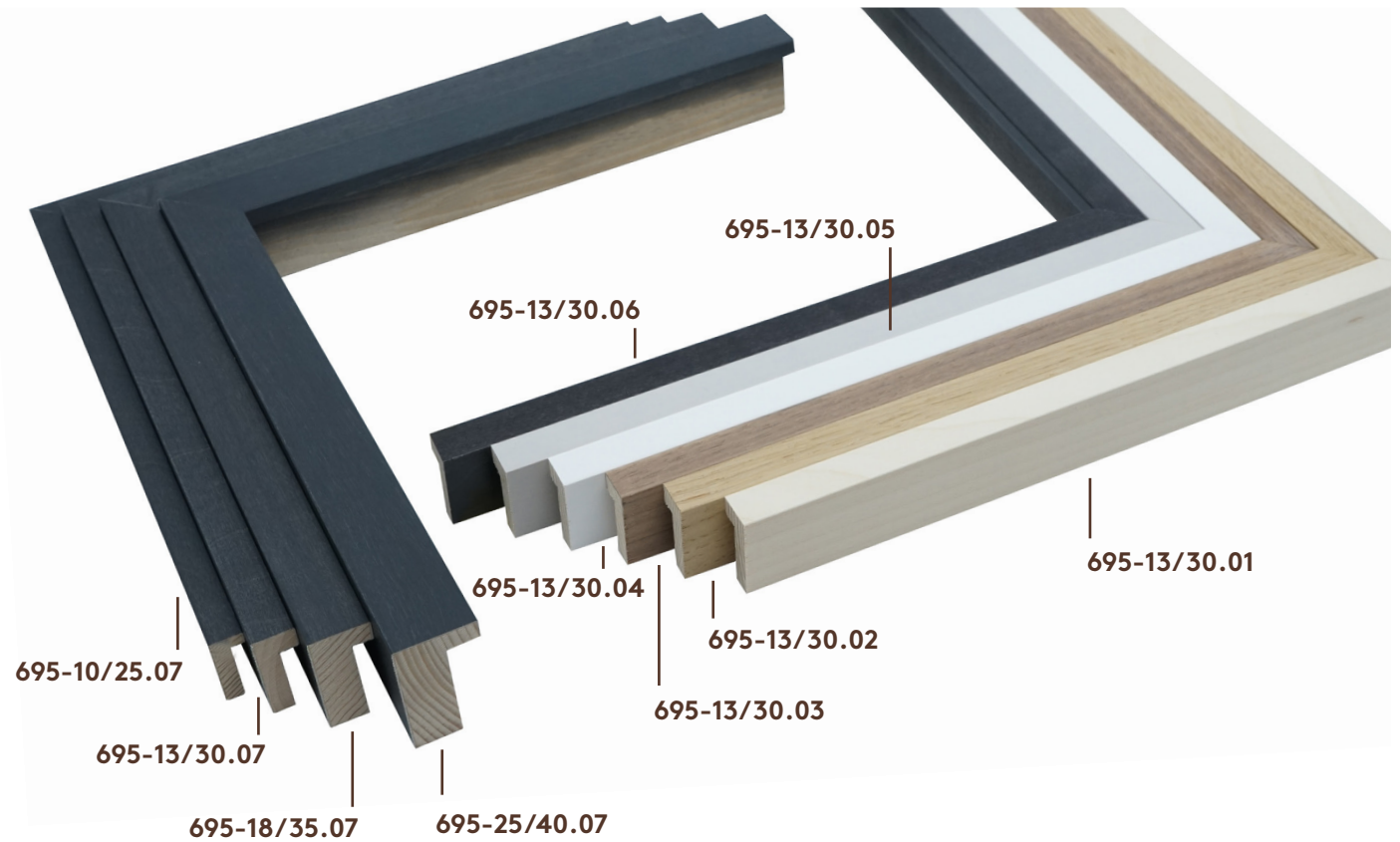

Josef

Pin//Europe, Amérique du Nord, Russie

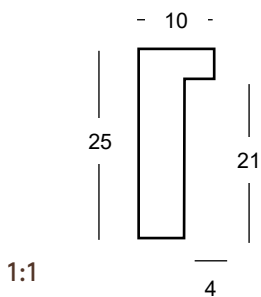

1:1

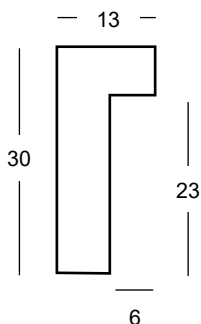

1:1

N° d'article	Désignation	N° tarif	Prix/ml
10210	695-10/25.01 érable plaqué	T: 1180	17.40
10214	695-10/25.02 chêne plaqué	T: 1180	17.40
10218	695-10/25.03 noyer plaqué	T: 1180	17.40
10222	695-10/25.04 extra-blanc	T: 1200	19.30
10226	695-10/25.05 gris-clair	T: 1200	19.30
10230	695-10/25.06 ébène	T: 1200	19.30
10234	695-10/25.07 anthracite	T: 1200	19.30
10211	695-13/30.01 érable plaqué	T: 2190	18.40
10215	695-13/30.02 chêne plaqué	T: 2190	18.40
10219	695-13/30.03 noyer plaqué	T: 2190	18.40
10223	695-13/30.04 extra-blanc	T: 2210	20.30
10227	695-13/30.05 gris-clair	T: 2210	20.30
10231	695-13/30.06 ébène	T: 2210	20.30
10235	695-13/30.07 anthracite	T: 2210	20.30

N° d'article	Désignation	N° tarif	Prix/ml
--------------	-------------	----------	---------

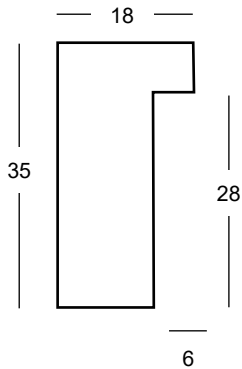

10212	695-18/35.01 érable plaqué	T: 2200	19.60
10216	695-18/35.02 chêne plaqué	T: 2200	19.60
10220	695-18/35.03 noyer plaqué	T: 2200	19.60
10224	695-18/35.04 extra-blanc	T: 2220	21.80
10228	695-18/35.05 gris-clair	T: 2220	21.80
10232	695-18/35.06 ébène	T: 2220	21.80
10236	695-18/35.07 anthracite	T: 2220	21.80

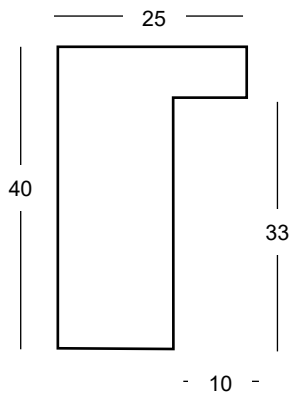

10213	695-25/40.01 érable plaqué	T: 3220	21.80
10217	695-25/40.02 chêne plaqué	T: 3220	21.80
10221	695-25/40.03 noyer plaqué	T: 3220	21.80
10225	695-25/40.04 extra-blanc	T: 3260	25.20
10229	695-25/40.05 gris-clair	T: 3260	25.20
10233	695-25/40.06 ébène	T: 3260	25.20
10237	695-25/40.07 anthracite	T: 3260	25.20



Paul

Pin, Érable, Chêne, Noyer // Suisse, États Unis, Europe, Amérique du Nord, Russie

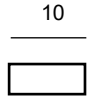
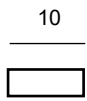
	N° d'article	Désignation	N° tarif	Prix/ml
1:1 3.5 	10277	696-3.5/5.04 extra-blanc	T: 180	7.40
	10278	696-3.5/5.05 gris-clair	T: 180	7.40
	10282	696-3.5/5.06 ébène	T: 180	7.40
	10283	696-3.5/5.07 anthracite	T: 180	7.40
1:1 4  3.5 	55809	7030-4/10 érable	T: 150	4.60
	55810	7030-4/10 chêne	T: 150	4.40
	55811	7030-4/10 noyer	T: 170	7.10
	10238	696-3.5/10.04 extra-blanc	T: 190	8.20
	10239	696-3.5/10.05 gris-clair	T: 190	8.20
	10240	696-3.5/10.06 ébène	T: 190	8.20
	10241	696-3.5/10.07 anthracite	T: 190	8.20

	N° d'article	Désignation	N° tarif	Prix/ml
<p>10 5</p>	09836	7030-5/10 érable	T: 150	4.60
	53066	7030-5/10 chêne	T: 150	4.40
	55835	7030-5/10 noyer	T: 180	7.10
	10242	696-5.5/10.04 extra-blanc	T: 190	8.70
	10243	696-5.5/10.05 gris-clair	T: 190	8.70
	10244	696-5.5/10.06 ébène	T: 190	8.70
	10245	696-5.5/10.07 anthracite	T: 190	8.70
<p>15 5</p>	09840	7030-5/15 érable	T: 160	5.10
	09839	7030-5/15 chêne	T: 150	5.00
	55841	7030-5/15 noyer	T: 190	8.70
	10246	696-5.5/15.04 extra-blanc	T: 1110	10.10
	10247	696-5.5/15.05 gris-clair	T: 1110	10.10
	10248	696-5.5/15.06 ébène	T: 1110	10.10
	10249	696-5.5/15.07 anthracite	T: 1110	10.10
<p>20 5</p>	09843	7030-5/20 érable	T: 160	5.30
	09842	7030-5/20 chêne	T: 160	5.40
	55847	7030-5/20 noyer	T: 1100	9.80
	10250	696-5.5/20.04 extra-blanc	T: 1120	11.70
	10251	696-5.5/20.05 gris-clair	T: 1120	11.70
	10252	696-5.5/20.06 ébène	T: 1120	11.70
	10253	696-5.5/20.07 anthracite	T: 1120	11.70
<p>10 9</p>	10258	7030-9/10 érable	T: 180	7.60
	10259	7030-9/10 chêne	T: 1130	12.10
	10260	7030-9/10 noyer	T: 1150	14.80
	10254	696-9.5/10.04 extra-blanc	T: 1120	11.70
	10255	696-9.5/10.05 gris-clair	T: 1120	11.70
	10256	696-9.5/10.06 ébène	T: 1120	11.70
	10257	696-9.5/10.07 anthracite	T: 1120	11.70
<p>15 9</p>	10265	7030-9/15 érable	T: 1110	10.50
	10266	7030-9/15 chêne	T: 1120	11.70
	10267	7030-9/15 noyer	T: 1180	17.20
	10261	696-9.5/15.04 extra-blanc	T: 1140	13.30
	10262	696-9.5/15.05 gris-clair	T: 1140	13.30
	10263	696-9.5/15.06 ébène	T: 1140	13.30
	10264	696-9.5/15.07 anthracite	T: 1140	13.30
<p>20 9</p>	10274	7030-9/20 érable	T: 1120	11.50
	10275	7030-9/20 chêne	T: 1140	13.20
	10276	7030-9/20 noyer	T: 1200	19.20
	10268	696-9.5/20.04 extra-blanc	T: 1150	15.00
	10269	696-9.5/20.05 gris-clair	T: 1150	15.00
	10272	696-9.5/20.06 ébène	T: 1150	15.00
	10273	696-9.5/20.07 anthracite	T: 1150	15.00



von der kunst zu rahmen
l'art accompli d'encadrer

emsa.ch

EMSA Rahmenleisten AG
Durisolstrasse 6
CH-5612 Villmergen
T +41 (0)56 619 10 20
F +41 (0)56 619 10 59
info@emsa.ch